

ONKYO®

Digital Media Transport

ND-S1

Instruction Manual

Important Safety Instructions .. 2
Precautions 3

Features..... 4

Supplied Accessories..... 5

Getting to Know the ND-S1 6

Using the Remote Controller ... 7

Connecting the ND-S1..... 8

**Playing the Music and Videos on
Your iPod 10**

Syncing Your iPod to Your PC.. 12

**Playing the Music on Your PC
Through the ND-S1 13**

Troubleshooting 14

Specifications..... 15



USB

Thank you for purchasing an Onkyo product. Please read this manual carefully before making any connections or using this product. By following these instructions, you'll get the best audio performance and the most listening pleasure from your Onkyo product. Keep this manual for future reference.



WARNING:

TO REDUCE THE RISK OF FIRE OR ELECTRIC SHOCK, DO NOT EXPOSE THIS APPARATUS TO RAIN OR MOISTURE.

CAUTION:

TO REDUCE THE RISK OF ELECTRIC SHOCK, DO NOT REMOVE COVER (OR BACK). NO USER-SERVICEABLE PARTS INSIDE. REFER SERVICING TO QUALIFIED SERVICE PERSONNEL.



WARNING
RISK OF ELECTRIC SHOCK
DO NOT OPEN

AVIS
RISQUE DE CHOC ELECTRIQUE
NE PAS OUVRI



The lightning flash with arrowhead symbol, within an equilateral triangle, is intended to alert the user to the presence of uninsulated "dangerous voltage" within the product's enclosure that may be of sufficient magnitude to constitute a risk of electric shock to persons.



The exclamation point within an equilateral triangle is intended to alert the user to the presence of important operating and maintenance (servicing) instructions in the literature accompanying the appliance.

Important Safety Instructions

1. Read these instructions.
2. Keep these instructions.
3. Heed all warnings.
4. Follow all instructions.
5. Do not use this apparatus near water.
6. Clean only with dry cloth.
7. Do not block any ventilation openings. Install in accordance with the manufacturer's instructions.
8. Do not install near any heat sources such as radiators, heat registers, stoves, or other apparatus (including amplifiers) that produce heat.
9. Do not defeat the safety purpose of the polarized or grounding-type plug. A polarized plug has two blades with one wider than the other. A grounding type plug has two blades and a third grounding prong. The wide blade or the third prong are provided for your safety. If the provided plug does not fit into your outlet, consult an electrician for replacement of the obsolete outlet.
10. Protect the power cord from being walked on or pinched particularly at plugs, convenience receptacles, and the point where they exit from the apparatus.
11. Only use attachments/accessories specified by the manufacturer.
12. Unplug this apparatus during lightning storms or when unused for long periods of time.
13. Refer all servicing to qualified service personnel. Servicing is required when the apparatus has been damaged in any way, such as power-supply cord or plug is damaged, liquid has been spilled or objects have fallen into the apparatus, the apparatus has been exposed to rain or moisture, does not operate normally, or has been dropped.
14. **Damage Requiring Service**
Unplug the apparatus from the wall outlet and refer servicing to qualified service personnel under the following conditions:
 - A. When the power-supply cord or plug is damaged,
 - B. If liquid has been spilled, or objects have fallen into the apparatus,
 - C. If the apparatus has been exposed to rain or water,
 - D. If the apparatus does not operate normally by following the operating instructions. Adjust only those controls that are covered by the operating instructions as an improper adjustment of other controls may result in damage and will often require extensive work by a qualified technician to restore the apparatus to its normal operation,
 - E. If the apparatus has been dropped or damaged in any way, and
 - F. When the apparatus exhibits a distinct change in performance this indicates a need for service.

Precautions

- 1. Recording Copyright**—Unless it's for personal use only, recording copyrighted material is illegal without the permission of the copyright holder.
- 2. Care**—Occasionally you should dust the unit all over with a soft cloth. For stubborn stains, use a soft cloth dampened with a weak solution of mild detergent and water. Dry the unit immediately afterwards with a clean cloth. Don't use abrasive cloths, thinners, alcohol, or other chemical solvents, because they may damage the finish or remove the panel lettering.
- 3. Never Touch this Unit with Wet Hands**—Never handle this unit or its power cord while your hands are wet or damp. If water or any other liquid gets inside this unit, have it checked by your Onkyo dealer.
- 4.** Do not use other AC adapters, car power adapters, or battery holders containing regular or rechargeable batteries, as they may damage the product.

For U.S. models

FCC Information for User

CAUTION:

The user changes or modifications not expressly approved by the party responsible for compliance could void the user's authority to operate the equipment.

NOTE:

This equipment has been tested and found to comply with the limits for a Class B digital device, pursuant to Part 15 of the FCC Rules. These limits are designed to provide reasonable protection against harmful interference in a residential installation.

This equipment generates, uses and can radiate radio frequency energy and, if not installed and used in accordance with the instructions, may cause harmful interference to radio communications. However, there is no guarantee that interference will not occur in a particular installation. If this equipment does cause harmful interference to radio or television reception, which can be determined by turning the equipment off and on, the user is encouraged to try to correct the interference by one or more of the following measures:

- Reorient or relocate the receiving antenna.
- Increase the separation between the equipment and receiver.

- Connect the equipment into an outlet on a circuit different from that to which the receiver is connected.
- Consult the dealer or an experienced radio/TV technician for help.

For Canadian Models

NOTE: THIS CLASS B DIGITAL APPARATUS COMPLIES WITH CANADIAN ICES-003.

Modèle canadien

REMARQUE: CET APPAREIL NUMÉRIQUE DE LA CLASSE B EST CONFORME À LA NORME NMB-003 DU CANADA.

For some models

Before use, connect the appropriate AC plug adapter to the AC adapter.

The type of plug adapter depends on the place of purchase.

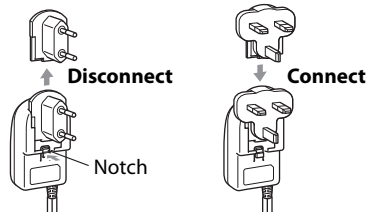

For European Models

Declaration of Conformity	
We, ONKYO EUROPE ELECTRONICS GmbH LIEGNITZERSTRASSE 6, 82194 GROEBENZELL, GERMANY	
declare in own responsibility, that the ONKYO product described in this instruction manual is in compliance with the corresponding technical standards such as EN60065, EN55013, EN55020 and EN61000-3-2, -3-3.	
GROEBENZELL, GERMANY	 K. MIYAGI
ONKYO EUROPE ELECTRONICS GmbH	

Features

- With the Onkyo ND-S1 Digital Media Transport, you can easily play the music stored on your iPod through your Onkyo audio system and enjoy great sound.
- The ND-S1 processes the digital audio signal directly from your iPod for high-quality digital audio output (optical or coaxial).
- The built-in USB audio interface allows you to output the music stored on your PC digitally (optical or coaxial).
- Music stored on your PC can be output digitally even when the ND-S1 is powered by only the USB bus.¹
- Easily sync your iPod with your iTunes music library on your PC.
- If your iPod supports TV out, connecting the ND-S1's VIDEO jack to your TV or AV receiver allows you to enjoy videos.
- In addition to the included remote controller, you can also use your Onkyo amp or AV receiver's remote controller.²
- The ND-S1 charges your iPod while you enjoy your music.

1. When powered by only the USB bus, some iPod functionality is not available and your iPod will not be charged, so always use the included AC adapter when possible.

2. Only **RI**-capable Onkyo amp and AV receiver remote controllers are supported. If the remote controller supplied with your Onkyo amp or AV receiver has separate POWER ON and STANDBY buttons, operation is as follows:

- When the amp or AV receiver is set to Standby, only the amp or AV receiver turns On.
- When the amp or AV receiver is already On, the ND-S1 turns On.

So to turn on the ND-S1 when the amp or AV receiver is set to Standby, on the remote controller supplied with your amp or AV receiver, you must press the [ON] button twice.

Recommended iPod Models

- iPod nano (2nd generation)
- iPod nano (3rd generation)
- iPod classic
- iPod touch
- iPod nano (4th generation)
- iPod touch (2nd generation)

iPod Models with Limited Support:

- iPod nano
- iPod (5th generation)

* iPod is a trademark of Apple Inc., registered in the U.S. and other countries.

"Made for iPod" means that an electronic accessory has been designed to connect specifically to iPod and has been certified by the developer to meet Apple performance standards.

Apple is not responsible for the operation of this device or its compliance with safety and regulatory standards.

Notes:

- On the 5th generation iPod and iPod nano, the click wheel is disabled during playback. Use the ND-S1's [iPod] button to start and stop playback and the remote controller to control other iPod functions.
- Before using the ND-S1, update your iPod with the latest software, available from the Apple Web site at: www.apple.com

- The instructions in this manual apply to iPod models as of June 2009 and may change with future upgrades to the iPod software.
- Several generations of some iPod models have been sold. An iPod without "xxx generation" in its name indicates the first generation of that particular iPod.
- The AC adapter supplied with the ND-S1 is designed exclusively for use with the ND-S1. Do not use it with any other device. Likewise, do not use any other AC adapter with the ND-S1. Doing so may damage the ND-S1.

Supplied Accessories

Make sure you have the following accessories.

- **AC adapter**



- **Optical audio cable**

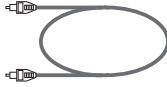

- **Remote controller**

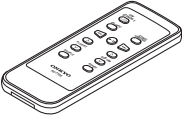

- **USB cable**

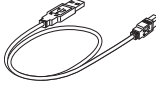

- **Video cable**

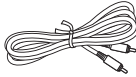

- **RI cable**



- **Instruction Manual**

* In catalogs and on packaging, the letter at the end of the product name indicates the color. Specifications and operations are the same regardless of color.

Getting to Know the ND-S1

Front and Top

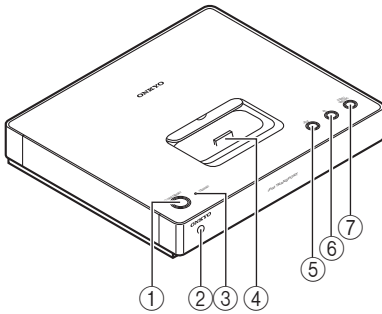

- ① **ON/STANDBY button**
Sets the ND-S1 to On or Standby.
- ② **Remote control sensor**
Receives control signals from the remote controller.
- ③ **STANDBY indicator**
Lights up when the ND-S1 is on Standby. If your iPod is charging during Standby, it flashes slowly.
- ④ **iPod dock connector**
Connects to your iPod.
- ⑤ **iPod button/indicator**
Press this button to use your iPod. Press repeatedly to start and stop iPod playback. The indicator lights up blue when your iPod is selected.
- ⑥ **PC button/indicator**
With the ND-S1 connected to your PC via USB, press this button to output the music stored on your PC digitally from the ND-S1. The indicator lights up green when your PC is selected.
- ⑦ **SYNC/UNSYNC button/indicator**
With the ND-S1 connected to your PC via USB, and your iPod inserted in the ND-S1, press this button to sync your iPod with your iTunes music library on your PC. The indicator lights up red while sync is in progress. To cancel sync, press and hold this button for at least 2 seconds. The indicator will flash for a few moments and stop flashing when

sync has been cancelled. While the indicator is flashing, you cannot operate any buttons or start iPod playback. See page 12 for details.

Rear Panel

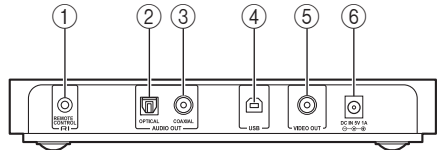

- ① **RI REMOTE CONTROL jack**
Connects to the RI jack on another RI-capable Onkyo component for linked operation. This connection should not be used with some components. See page 8 for details.
- ② **OPTICAL AUDIO OUT jack**
This optical digital audio output jack connects to an optical digital audio input on a system component, amp, or AV receiver.
- ③ **COAXIAL AUDIO OUT jack**
This coaxial digital audio output jack connects to a coaxial digital audio input on a system component, amp, or AV receiver.
- ④ **USB port**
Connects to a USB port on your PC for playing music stored on your PC and iTunes sync.
- ⑤ **VIDEO OUT jack**
Connects to a composite video input on your TV or AV receiver for video playback.
- ⑥ **DC IN 5V 1A jack**
Connect the included AC adapter here.

Using the Remote Controller

Aiming the Remote Controller

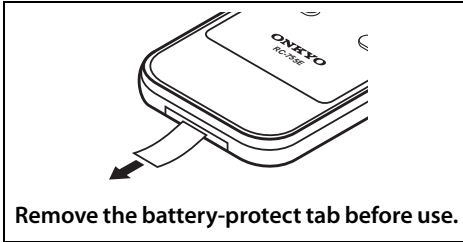

Point the included remote controller toward the ND-S1's remote control sensor, as shown.

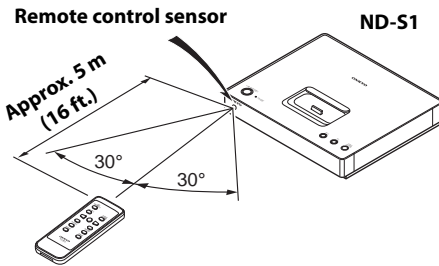

Notes:

- The remote controller may not work reliably if the ND-S1 is subjected to bright light, such as direct sunlight or inverter-type fluorescent lights. Keep this in mind when installing.
- If another remote controller of the same type is used in the same room, or the ND-S1 is installed close to equipment that uses infrared rays, the remote controller may not work reliably.
- Don't put anything on top of the remote controller, such as a book or magazine, because a button may be pressed continuously, thereby draining the battery.
- The remote controller may not work reliably if the ND-S1 is installed in a rack behind colored glass doors. Keep this in mind when installing.
- The remote controller will not work if there's an obstacle between it and the ND-S1's remote control sensor.

Replacing the Battery

The included remote controller uses a CR2025 type battery. Always use with the same type.

1. To open the battery compartment, press the small hollow and slide open the cover.

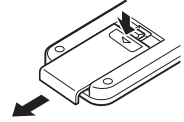

2. While pressing the tab as shown, slide out the old battery.

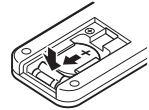

3. Slide the new battery into the compartment with the positive (+) side facing up.

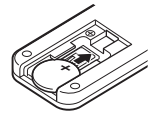

4. Slide the cover shut.

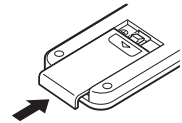

Notes:

- If the remote controller doesn't work reliably, try replacing the battery.
- If you intend not to use the remote controller for a long time, remove the battery to prevent damage from leakage or corrosion.
- An expired battery should be removed as soon as possible to prevent damage from leakage or corrosion.
- Misuse of lithium batteries may cause a fire or chemical burn. Always keep out of reach of children. Never disassemble, charge, heat above 100°C, or incinerate.

CAUTION:

Danger of explosion if battery is incorrectly replaced. Replace only with the same or equivalent type.

Connecting the ND-S1

Connecting an Amp or AV Receiver

Connect the ND-S1 to a digital audio input on your Onkyo amp or AV receiver that can be assigned to an input selector whose Input Display can be set to "DOCK." Setup varies depending on your particular amp or AV receiver model. Refer to the Digital Input Setup and Changing the Display sections of your amp or AV receiver's instruction manual for details.

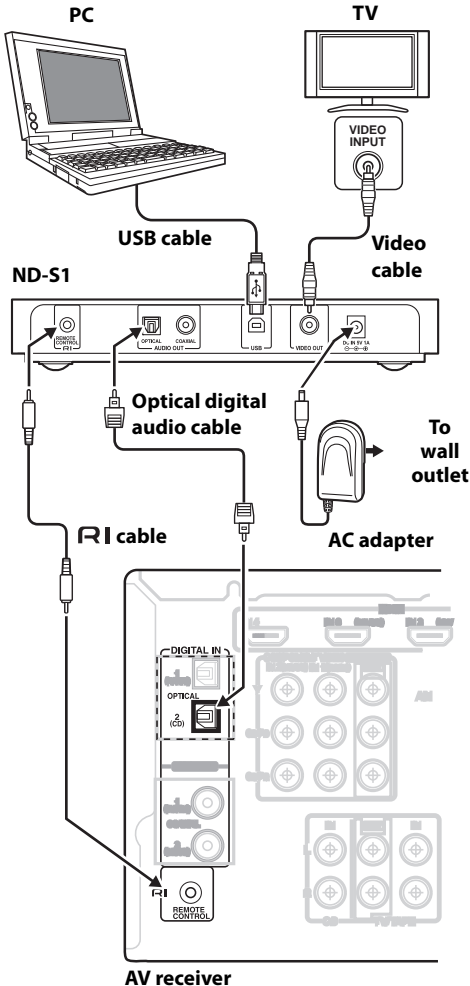

1. Using the included optical audio cable, connect the ND-S1's OPTICAL AUDIO OUT jack to an optical digital audio input jack on your amp or AV receiver.
2. If your iPod supports TV out, use the included video cable to connect the ND-S1's VIDEO OUT jack to a composite video input on your TV or AV receiver.
3. Using the included RI cable, connect the ND-S1's RI REMOTE CONTROL jack to an RI jack on your amp or AV receiver.
4. Connect the included AC adapter to the ND-S1's DC IN 5V 1A jack, and plug the AC adapter into a suitable wall outlet.

Notes:

- The ND-S1's audio outputs are digital outputs. If the digital audio input on your amp or AV receiver cannot be assigned to an input selector whose Input Display can be set to "DOCK," do not connect the RI cable, otherwise a malfunction may occur.
- Do not place the ND-S1 on top of a component that gets warm or one with has air vents on top, as it may interfere with that component's cooling or cause the component or ND-S1 to overheat. Place it next to the component, use an audio rack, etc.

Inserting Your iPod into the ND-S1

Prepare the adapter that came with your iPod.

1. Gently push down and slide open the dock cover on the ND-S1.

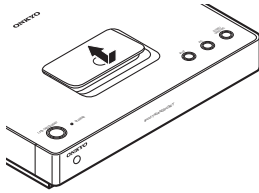

2. Insert the adapter supplied with your iPod, then push your iPod firmly onto the ND-S1's dock connector.

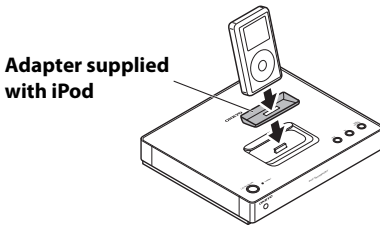

Notes:

- If you use a case with your iPod, always remove it before you insert it. Otherwise, it may not connect properly and a malfunction may occur.
- Do not insert your iPod into the ND-S1 without the adapter that came with it, as it may put unnecessary strain on the iPod or ND-S1's dock connector, causing permanent damage.

When you insert your iPod, the ND-S1 works as follows depending on the status of your iPod.

• iPod not playing:

The ND-S1 starts charging your iPod and the STANDBY indicator flashes slowly.

• iPod playing:

The ND-S1 turns on, the [iPod] indicator lights up blue, and your iPod continues playing.

Notes:

- If the [iPod] indicator does not light up after you've inserted your iPod, this means that your iPod is not properly seated on the dock connector. Make sure your iPod is seated properly on the dock connector.
- To prevent dock connector damage, don't twist your iPod when inserting or removing it, and be careful not to knock your iPod while it's inserted.
- Don't use your iPod with any other accessories, such as FM transmitters and microphones, because they may cause a malfunction.

■ Removing the iPod Adapter

To remove the iPod adapter from the ND-S1, insert a small flathead screwdriver into the slot, and lift it out, as shown below.

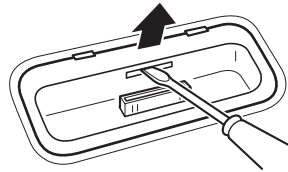

Playing the Music and Videos on Your iPod

Music and Video Playback

1. On your iPod, select the song or video you want to play.
2. Insert your iPod into the ND-S1 (see page 9).
3. Press the remote controller's Play/Pause [▶||] button, or the ND-S1's [iPod] button to start playback.

See below for additional remote controller operation and system functions.

Remote Controller Button Operation

You can use the following buttons to control your iPod. Actual operation may vary depending on your iPod model, its generation, and firmware version.

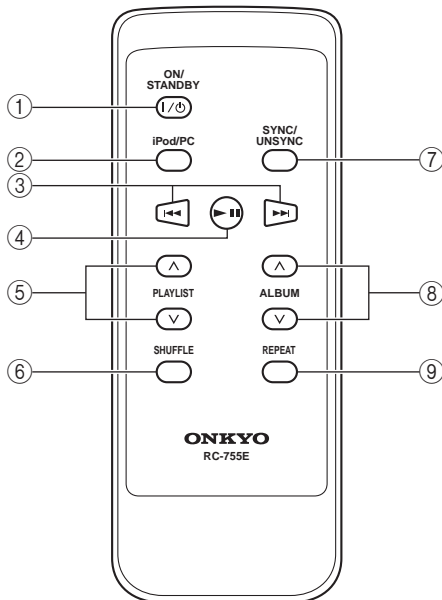

- ① **ON/STANDBY button**
Sets the ND-S1 to On or Standby.
- ② **iPod/PC button**
Press repeatedly to select your iPod or PC.
- ③ **Previous/Next [◀◀]/[▶▶] buttons**
During playback or while playback is paused, press the Next [▶▶] button to

select the next song. Press the Previous [◀◀] button to return to the beginning of the current song, press again to select previous songs.

Press and hold to fast forward or rewind.

- ④ **Play/Pause [▶||] button**
Press to start playback on your iPod. Your iPod will turn on automatically if it's not already on. Press the button again to pause playback.
- ⑤ **PLAYLIST Up/Down [^]/[v] buttons**
If your iPod contains playlists, press the PLAYLIST Up [^] button to select the previous playlist. Press the PLAYLIST Down [v] button to select the next playlist on your iPod.
- ⑥ **SHUFFLE button**
Press repeatedly to set the shuffle function on your iPod (Song, Album, or Off).
- ⑦ **SYNC/UNSYNC button**
Press to start or cancel iPod sync. The indicator shows the current status.
- ⑧ **ALBUM Up/Down [^]/[v] buttons**
Used to change albums.
To change album, start album or all song playback, then press the ALBUM Up/Down [^]/[v] buttons.
- ⑨ **REPEAT button**
Press repeatedly to set the repeat function on your iPod (One, All, or Off).

Some of the iPod functions that you can control with this remote controller can also be controlled with the remote controller that came with your amp or AV receiver. Refer to the instruction manual that came with your amp or AV receiver for details.

See pages 8 to 9 for connection information.

System Functions

You can use the following system functions:

■ System On

When you turn on your amp or AV receiver, the ND-S1 and iPod turn on automatically. In addition, when the ND-S1 and iPod are on, some amps and AV receivers can be turned on by pressing the [ON/STANDBY] button.

■ System Off

When you turn off your amp or AV receiver, the ND-S1 and iPod automatically go on Standby.

■ Timer Off

If you set your amp or AV receiver's sleep timer, the ND-S1 and iPod will automatically switch to Standby at the specified sleep time.

■ Timer Play

If you set your amp or AV receiver's play timer, the ND-S1 and iPod will automatically turn on and your iPod will start playback at the specified time.

■ Auto Power On

If you press the remote controller's Play/Pause [▶||] button while your amp or AV receiver is on Standby, your amp or AV receiver will turn on automatically, select your iPod as the input source, and your iPod will start playback.

■ Direct Change

if you start iPod playback while listening to another input source, your amp or AV receiver will automatically switch to the input to which the ND-S1 is connected.

■ Other Remote Controllers

You can use the remote controller that came with your amp or AV receiver to control other iPod functions. The available functionality depends on your amp or AV receiver. See the instruction manual that came with your amp or AV receiver for details.

■ iPod Alarm

If you use the Alarm function on your iPod to start playback, your amp or AV receiver will turn on at the specified time and select your iPod as the input source automatically.

Notes:

- Linked operations do not work with video playback or when the alarm is set to play a sound.
- If you use your iPod with any other accessories, iPod playback detection may not work.

■ Operating Notes

- Use your amp or AV receiver's volume control to adjust the playback volume.
- While your iPod is inserted in the ND-S1, its volume control has no effect.
- If you do adjust the volume control on your iPod while it's inserted in the ND-S1, be careful that it's not set too loud before you reconnect your earphones.

Note:

- On the 5th generation iPod and iPod nano, the click wheel is disabled during playback. Use the ND-S1's [iPod] button to start and stop playback and the remote controller to control other iPod functions.

Syncing Your iPod to Your PC

You can transfer songs and videos from your iTunes music library on your PC to your iPod by using sync. (Videos are restricted to iPod models that support video.)

1. **Using the included USB cable, connect the ND-S1's USB port to a USB port on your PC.**
2. **Press the [SYNC/UNSYNC] button.**
The indicator lights up red, iTunes opens on your PC, and sync starts.

ND-S1

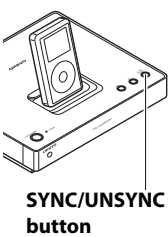

Remote controller

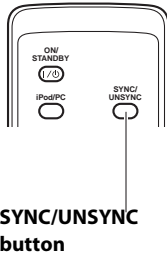

Note:

- In the iTunes settings, if the “Automatically sync when this iPod is connected” option is not selected, iTunes will not open automatically and you’ll have to start iTunes manually.

Note:

Follow the steps below if you want to cancel sync. Failure to follow these steps may result in data loss or malfunction.

1. **In iTunes, click the Eject button to eject your iPod.**
2. **Press and hold the [SYNC/UNSYNC] button for at least 2 seconds.**
After a few moments, the [SYNC/UNSYNC] indicator flashes, indicating sync has been cancelled.

■ **iTunes Restore Function**

If iTunes detects any damaged data on your iPod, it will attempt to restore it. When the restore process is complete, the ND-S1's sync function may cancel automatically, in which case you'll need to press the [SYNC/UNSYNC] button again to sync.

The following operating systems are supported: Windows XP, Windows Vista.

- * iTunes is a trademark of Apple Inc., registered in the U.S. and other countries.
- * Windows and Windows Vista are either registered trademarks or trademarks of Microsoft Corporation in the United States and/or other countries.

Playing the Music on Your PC Through the ND-S1

By connecting the ND-S1 to a USB port on your PC, you can play the music stored on your PC through your Onkyo audio system.

1. **Using the included USB cable, connect the ND-S1's USB port to a USB port on your PC.**
2. **Press the ND-S1's [PC] button, or the [iPod/PC] button on the included remote controller to select PC.**
The [PC] indicator lights up green.

ND-S1

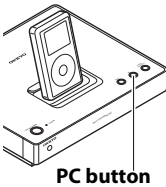

Remote controller

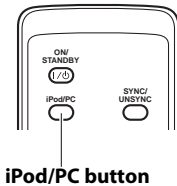

3. **Start music playback on your PC.**
Use your amp or AV receiver's volume control to adjust the playback volume.

Note:

- If the ND-S1 is not recognized as a USB audio device even after restarting your PC, in the Control Panel, open "Sounds & Audio Devices" and select "USB Audio DAC" as the default sound playback device. For more information, see the "Sound Troubleshooter" in Windows Help.

Troubleshooting

No Sound or Video

- Make sure your iPod is connected properly.
- If there's no video, make sure your iPod supports TV out.
- Make sure your iPod is playing.
- Make sure your amp or AV receiver is turned on, the input to which the ND-S1 is connected is selected as the input source, and the volume control is not set to minimum.
- Make sure all plugs are pushed in all the way.
- Make sure the ND-S1 is connected to the correct input jacks on your amp or AV receiver. If there's no video, check your video connections. Do not connect the ND-S1 to any jacks on your amp or AV receiver labeled OUT.
- Make sure the AC adapter is properly connected to the ND-S1 and a suitable wall outlet.
- Try resetting your iPod.
- If you remove then re-insert your iPod, it may not be recognized temporarily. In this case, press and hold down the ND-S1's [iPod] button for at least 2 seconds to reset the ND-S1. If it's still not recognized, disconnect the USB cable and AC adapter, then reconnect them.

Remote Controller doesn't work

- Make sure your iPod is seated properly on the dock connector. If your iPod is in a case, it may not connect properly, so always remove the case before inserting your iPod into the ND-S1.
- Your iPod cannot be controlled while it's displaying the Apple logo.
- If your remote controller has Remote Mode buttons, make sure the mode necessary to control your iPod is selected.
- If you're using the remote controller that came with your amp or AV receiver, be sure to point it toward your amp or AV receiver when you want to control your iPod.
- An **RI** cable connection is required with some components, but not others. If you connect it by mistake, remote control may not work. See page 8 for details.
- Try resetting your iPod.

Others

- Before using one of the other components connected to your amp or AV receiver, stop playback on your iPod. If playback is not stopped, the Direct Change function may select your iPod as the input source by mistake at the transition between songs.
- Depending on the backlight setting on your iPod, the display may become dim during use. If the display is hard to see, change the backlight setting on your iPod.
- Do not use Cover Flow while playing music on your iPod, as it may stop iPod playback or cause noise.

Specifications

Power supply:	100–240 V AC adapter (5V/1A)
Power consumption:	3.5 W
USB consumption:	250 mA
Standby consumption:	Less than 0.4 W
Dimensions (W x H x D):	8-1/16 x 1-3/8 x 6-7/8 inches 205 x 35 x 175 mm
Weight:	1.17 lbs. (530 g)
Jacks:	Optical digital audio output, coaxial digital audio output, composite video output, USB port, R I jack

■ PC System requirements

- Windows XP (SP2 or later) or Windows Vista
- 1 GHz or faster processor
- At least 512 MB of memory
- 200 MB of free hard drive space to install iTunes (additional free space required to store music and videos)
- DirectX 9.0 compatible graphics adapter
- At least 32 MB of video memory
- 1024 x 768 or higher display resolution
- Internet connection

Specifications and appearance are subject to change without notice.